



# HEAVY DUTY

**Commercial vehicle NEWS + PROMOTION**  
**01.04. - 31.12.2023**

**MISSION: KLANN POSSIBLE**

*Time saving, safe, well thought out tools.*

**NEW**

KL-0173-460 K

**Rethreading  
tool kit**



**126**  
**Top deals**

## OPERATION BOARD

Made in Germany



### TIME SAVING

These tools especially save time and thus real money.



### SAFE WORK

With these tools, the focus is particularly on safety during use



### ONLY FROM GEDORE

These tools are protected by us by patent, utility model, or design patent



### MATERIAL-PROTECTING

These tools protect vehicle of spare parts from damage during removal and installation



### COMMERCIAL VEHICLES

These tools are especially developed and suited for the use on commercial vehicles



### TRANSPORTERS

These tools are especially developed and suited for the use on transporters



### AGRICULTURE

These tools are especially designed and suitable for use on agricultural vehicles

## KL-0080 SERIES

# REPAIR KITS FOR CABLE/PLUG CONNECTIONS

Clean drives, reliable assistance systems and completely autonomous driving as a goal.

What seems to be technically manageable today, will be extremely challenging during repair at the latest.

The advancing digitalisation of automotive engineering, requires a complex electromagnetic system that combines sensors, actuators and radio transmitters in a far-reaching line system.

Up to 8 km cables, thousand of plug connections and various shielding systems are installed in modern vehicles.

In order to prevent a negative effect on the vehicle weight, the lines are becoming thinner and the plug connections thus more and more difficult. The tiniest modification in the cable cross-sections or the plug connections can cause serious errors. Thus, a professional repair is essential that results in restoring the factory default settings.



The GEDORE KLANN EXPERIENCE even represents indepth knowledge in this particular area of vehicle repair. Resource-efficient, time-saving, safe, professional.



# NEW



Application video

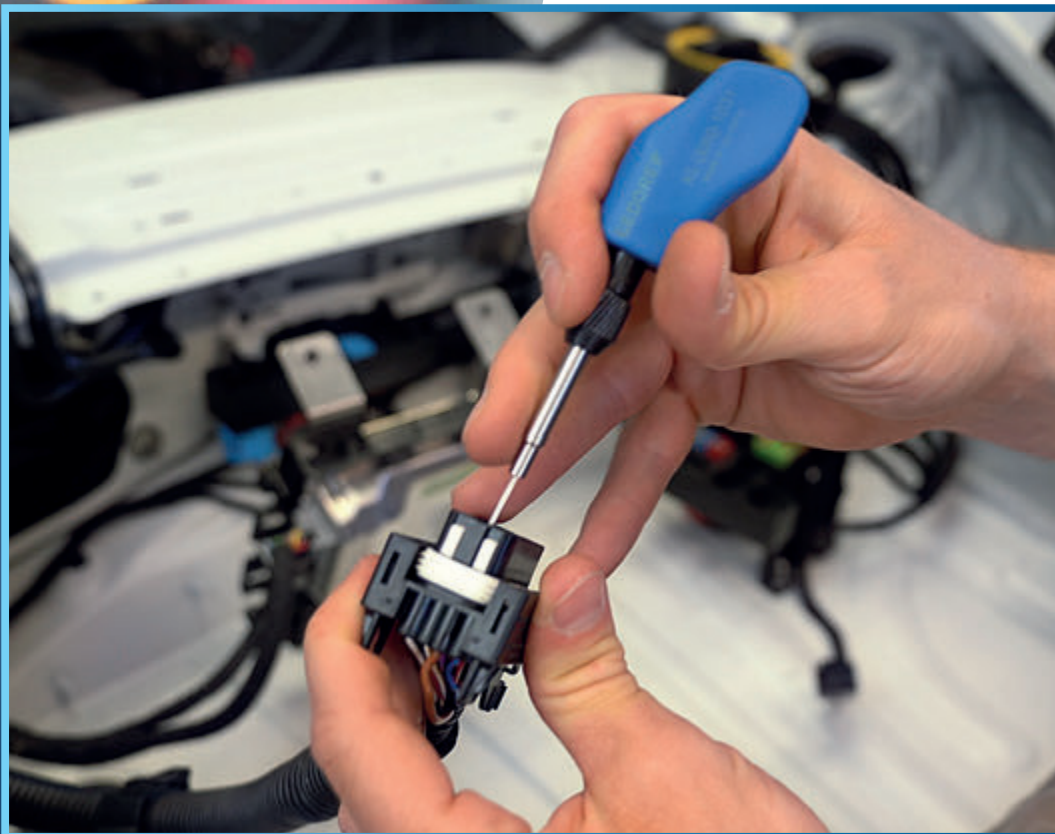

## Caution: System failure!

Oxidation or temporary repairs and plug connections do not only result in a time-consuming troubleshooting but can also lead to massive errors on the vehicle system. Sensor signals, actuator activation as well as data transfer on the CAN bus system can be massively disturbed. In the worst case, this can cause delays or the failure of the assistance systems!

The repair of FAKRA plug connections on for example GSM mobile radios, GPS systems and rear view cameras has also been a challenge so far. In this case, the transmission of high-frequency signals can be also massively disturbed due to already slightly visible oxidation on the plug connections or due to damaged shieldings. Until now, the only solution in most cases has been a time-consuming and costly exchange of the complete FAKRA coaxial cable in the entire vehicle.

The newly developed repair kits of the **KL-0080 series** enable the professional unlocking, stripping and controlled crimping of the most common cable / plug connections directly on the vehicle - quick and professional. The kits are supplied including suitable socket and plug contacts. Due to the interchangeable CRIMP heads, the repair kit can also be easily extended for many other plug connections in the future.



# NEW



## CRITICAL PLUG CONNECTIONS REPAIR SAFELY IN OEM QUALITY

KL-0080-1 K

### WIRING HARNESS REPAIR KIT with consumables



28piece + 1025 small parts

Made in Germany



Universally suitable for standard wire/terminal connections on passenger cars, commercial vehicles, vans, buses, construction machinery, agricultural machinery, trailers, and semi-trailers.

Especially for wire/terminal connections with and without single conductor seal (ELA), such as MCP-2.8, JPT, MQS, DTM/DT-twisted, SuperSeal-1.5, as well as for conventional crimp connections such as wire lugs, flat spade wire terminals, female flat spade wire terminals, butt connectors, etc.

**UNLOCKING, STRIPPING** and **CRIMPING**, all stored within easy reach in a clearly arranged case system.

Defective, oxidised, or provisionally repaired wire/terminal connections can lead to serious system failures on the vehicle. For this purpose, the repair kit for professionals in particular offers a comprehensive and robust assortment for the quick and professional repair of almost all common wire/terminal connections on the vehicle. Due to the unique and compact basic tool/changeable insert system, this can also be expanded as required in the future. The scope of delivery already includes a generous assortment of the most common contacts and seals.

**UNLOCKING:** Unlocking tool with matching interchangeable inserts for a damage-free release of a wide variety of cable/plug connections from the connector housing.

**STRIPPING:** Stripping tool with razor-sharp interchangeable inserts for precise stripping, especially for cables with extremely slippery PVC isolation.

**CRIMPING:** Crimping tool with interchangeable inserts for a perfect crimping result as ex works, guaranteed by the special cable / plug positioners. The tool can only be opened again when the pressure required for the crimping process has been fully applied.

Code	No.	Unlocking inserts	Stripping inserts	Crimping inserts:	Quantity per contact
3429814	KL-0080-1 K	7 pcs	2 pairs	11 pcs	25 pcs



# NEW

# CONNECTIONS

# QUALITY!



KL-0080-11 K

## REPAIR KIT

for FAKRA plug connections

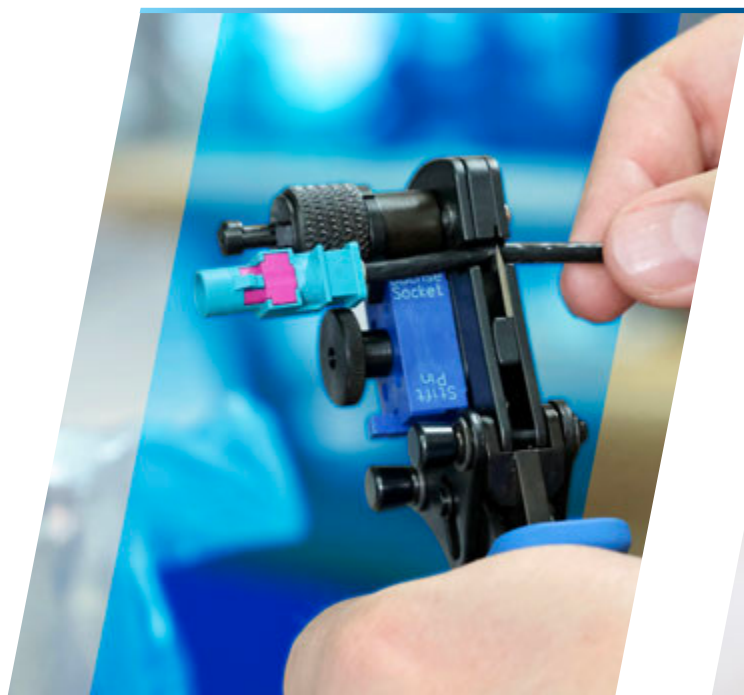

Made in Germany



Universal fit for cars, commercial vehicles, and vans with FAKRA cable/plug connections (RTK031 and RG174). Installed, for example, on GSM mobile radio antennas, GPS antennas, and in rear-view camera systems.

For quick and professional stripping, crimping, and repairing FAKRA cable/plug connections. Time-consuming replacement of the entire FAKRA coaxial cable, usually across the vehicle, is not required! Defective, oxidised, or provisionally repaired FAKRA cable/plug connections can lead to system failures on GSM mobile radios, GPS systems, and rear view camera systems.

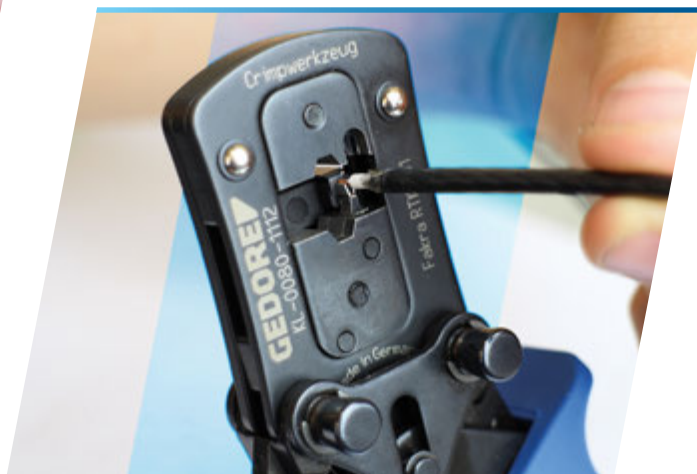

18 piece + 60 small parts

Code	No.	Cable diameter (RTK031)	Cable diameter (RG174)
3424634	KL-0080-11 K	3.2 mm	2.8 mm

KL-0190-28 K

## EJECTION TOOL KIT FOR PLUG-IN SLEEVES

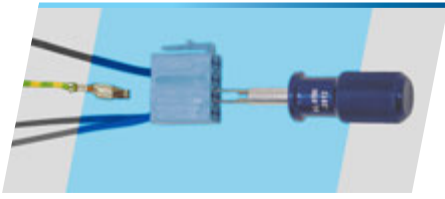

For unlocking cable plug connections.

- Professional, damage-free and safe working
- Simple handling
- High time saving
- Handy and ergonomic
- Short construction

Code	No.	Storage	Width	Depth	Height	Weight
2004119	KL-0190-28 K	In case	340 mm	290 mm	75 mm	1.1 kg



Made in Germany



KL-4600-200

## TOOL TROLLEY WITH HIGH VOLTAGE ASSORTMENT

- The perfect tool kit for maintenance and repairs on hybrid and electric vehicles
- Suitable for vehicles of all manufacturers
- All tools are protective insulated to EN 60900/EC 60900
- Tool trolley: Side walls with Euro perforation, externally mounted heavy-duty chassis, ball-bearing guide rails and central lock
- Included: digital voltage tester, 3/8" VDE torque spanner Safety lock, socket spanner and ratchet in 3/8" and 1/2", and many more.

### Content:

- 3/8" VDE tool kit with SW 6 - 22; XZN M8 - M12
- 3/8" VDE torque spanner 5 - 25 Nm
- 1/2" VDE tool kit with SW 10 - 24; IN 5 - 8 mm
- VDE single open-end spanner SW 9 - 24
- VDE single end ring spanner SW 8 - 22
- VDE slotted and cross-head screwdriver; TX T8 - T30
- VDE cable shear, VDE universal pliers, VDE power combination pliers, VDE power diagonal cutter, VDE flat nose-round pliers, angled, VDE flat pliers, VDE cable stripping knife
- Meter connection fittings
- Digital voltage tester 1, 000 V
- Electrician's protective gloves
- Undergloves
- Rubberised cloth cover 250 x 350 mm
- ISO insulation mat
- Barrier tape
- Warning sign "Flash"
- Warning sign high voltage "Switched ON",
- Warning sign high voltage "Switched OFF"
- Safety padlock
- Plastic clamp 80 mm; 160 mm
- Cable splitting wedge
- Rubber hammer

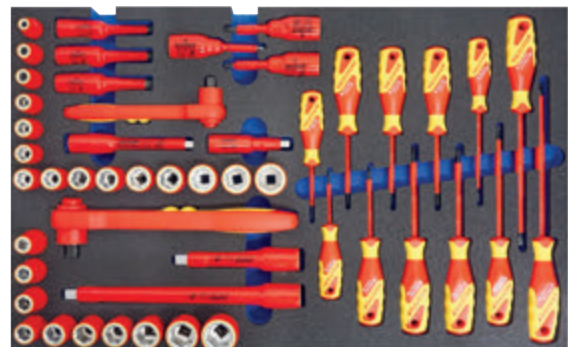

103 parts 3/8" 1/2" 1000 V

Code	No.	Dimensions	Number of drawers	Load capacity (mobile/static)	Load capacity (per drawer)	Design
3415740	KL-4600-200	H 985 x W 775 x D 475 mm	6	650 kg / 900 kg	40 kg	3/8" + 1/2"



1100-1094  
**VDE TOOL KIT  
HYBRID**

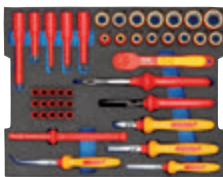

53 parts

- The perfect tool kit for maintenance and repairs on hybrid and electric vehicles
- Suitable for vehicles of all manufacturers
- All tools are protective insulated to EN 60900/EC 60900
- GEDORE L-BOXX® 136 is compatible to the Sortimo® vehicle equipment in your service car

Code	No.	Content	Depth (case)	Width (case)	Height (case)	Weight
2979063	1100-1094	3/8" VDE socket wrench no. VDE 30, 6 8 9 10 11 12 13 14 15 16 17 18 19 20 22 mm 3/8" VDE screwdriver bit no. VDE INX 30, 8 10 12 mm 3/8" VDE extension no. VDE 3090 -3 -6, 75 150 mm, 3/8" VDE reversible ratchet no. VDE 3093 U VDE slotted screwdriver no. VDE 2170, 2.5 3.5 4 5.5 mm VDE cross-head screwdriver no. VDE 2160 PH 1 2 3 VDE TX screwdriver no. VDE 2163 TX T20 T25 T30, VDE cable shear no. VDE 8094, 200 mm VDE universal pliers no. VDE 146 10, 10", VDE power combination pliers no. VDE 8250-200 H, 200 mm 2K handle VDE high leverage diagonal cutter no. VDE 8314-180 H, 180 mm VDE Flat round-nose pliers no. VDE 8132 AB-200 JC, 200 mm, angled 2K handle VDE flat pliers no. VDE 8120-160 H, 160 mm 2K handle VDE cable stripping knife no. VDE 4522, 180 mm, meter connection fitting no. V 914, size 1 2 3 + GEDORE L-BOXX®	357 mm	442 mm	151 mm	8.3 kg

KL-4600-100 K  
**VDE SUPPLEMENTARY KIT**



Made in Germany



Includes a digital HV tester!

- The unique VDE supplementary kit offers the possibility to secure hybrid and electric vehicles ideally for working on them
- Perfect addition to the VDE tool kit 1100-1094
- For maximum safety at the workplace
- includes an empty compartment to accommodate a VDE torque wrench 4508-02/-05

10 parts

Code	No.	Content	Weight
3413659	KL-4600-100 K	1x V 912 10 - Electrician's protective gloves incl. undergloves, 1x VDE 910 25 - Rubber cloth cover 250 x 350, 1x V 911 100 - ISO Insulation mat, 1x KL-4600-1001 - Barrier tape, 1x KL-4600-1002 - Warning sign "Flash", 1x KL-4600-1003 - Voltage tester 1.000 V, 1x KL-4600-1005 - Safety padlock, 1x KL-4600-1006 - Warning sign High voltage "Switched on", 1x KL-4600-1007 - Warning sign High voltage "Switched off" + GEDORE L-BOXX®	11 kg

KL-4600-10 Z  
**VDE HYBRID TOOL INCL. SUPPLEMENT**



**Complete package  
at a special price**

Code	No.	Consisting of
3418642	KL-4600-10 Z	KL-4600-100 K VDE supplementary kit and 1100-1094 VDE HYBRID tool kit

VDE 4616  
**VOLTAGE TESTER 1000 V**



- Display level: 12, 24, 50, 120, 230, 400, 690, 1000 V AC/ DC
- Acoustic and optical continuity test up to 100 kΩ
- Tested and approved according to DIN EN 61243-3, VDE 0682-401:2015
- Phase sequence, phase, polarity test

Code	No.	Measuring range	Design	Battery type	Length	Weight
3032744	VDE 4616	12 - 1,000 V	2-pole	AAA	120 mm	425 g

## KL-0870-10 K **VIDEOSCOPE** *with cleaning function*

Cleaning the air conditioner evaporator is usually done blind. Cleaning agent is sprayed into the ventilation shaft without knowing whether the affected areas have been reached precisely. With the help of the video endoscope with cleaning function **KL-0870-10 K**, cleaning can be carried out very precisely, saving time and money. The cleaning nozzle and the camera are mounted at a 90° angle to the cable/hose. This enables you to clean even hard-to-reach places.

The small lens with LED illumination delivers high-resolution images to the 3.5" LCD display. Images and videos can be saved with date and time stamp to provide the customer with detailed documentation. With this tool, the cleaning of the air conditioning evaporator is carried out extremely precisely and economically, thus saving time and money.



**NEW**



**NEW**



## KL-0880-10 K **VIDEOSCOPE** Ø 3.9 mm

Damage analysis on engines, transmissions, exhaust systems, etc. is always a difficult undertaking. In most cases, many add-on parts have to be dismantled or the component to be inspected has to be disassembled in order to carry out a meaningful visual inspection.

This is very time-consuming and costly, just to find out whether there is any damage at all, and if so, what kind. This can be avoided with the **KL-0880-10 K** video endoscope from Gedore Automotive. Due to its extremely small lens and a swivel range of over 360°, you can get to any part of the component to be inspected with only minor disassembly work. Thanks to the 3-stage LED illumination, everything can be optimally illuminated.

The videoscope is able to provide the images and videos with date and time stamp in order to offer the customer a detailed documentation of the damage analysis. The live images and recordings are displayed via a high-resolution HD colour display. Alternatively, it is possible to connect a smartphone or tablet to the device. The recordings are simply transferred to any computer via USB. This robust and at the same time very delicate tool saves a lot of time and money when troubleshooting.



KL-0870-10 K  
**VIDEOSCOPE**  
 with cleaning function



Universally applicable on cars, vans, commercial vehicles, buses, construction machinery, agricultural machinery.

- Enables the localisation and targeted removal of contamination.
- The transversely mounted camera with LED illumination and cleaning nozzle reaches even hard-to-reach places, e.g. the evaporator of the air-conditioning system.
- Slim camera unit Ø15x23 mm with powerful cleaning nozzle
- Dust- and water-proof lens with adjustable LED illumination
- For standard compressed air connection with 6 - 8 bar
- 250 ml container for cleaning fluids
- Live viewing via 3.5" colour display with zoom, rotate and mirror function
- Photo and video documentation with date/time stamp
- Incl. 8 GB microSD card and powerful 3.7 V lithium-polymer battery (1650mAh)
- Direct playback of photos and videos on the display

**NEW**

4parts

Code	No.	Display	Resolution	Cable diameter (max.)	Length, cable	Filling quantity	View angle	Operating pressure
3444929	KL-0870-10 K	3.5"	1280 x 720	23 mm	80 cm	250 ml	80°	6 - 8 bar

KL-0880-10 K  
**VIDEOSCOPE**  
 Ø 3.9 mm



Universally applicable on cars, vans, commercial vehicles, buses, construction machinery, agricultural machinery.

- Enables quick and easy inspection of extremely difficult-to-access components
- For professional damage analysis on engines, transmissions, intake systems, etc.
- Extremely slim Ø 3.9 mm micro camera with 1280x720 pixels
- Dust- and water-proof lens with adjustable LED illumination
- ±180° swivel angle due to 2-way joint
- Live viewing via 5.0" HD colour display with zoom, rotate and mirror function
- Photo and video documentation with date and time stamp
- Incl. 8 GB microSD card and powerful 3.7 V lithium-polymer battery (5000 mAh)
- Connection with smartphone, tablet and laptop etc. possible
- Direct playback of photos and videos on the display

**NEW**

8parts

Code	No.	Display	Resolution	Swivel angle	Cable diameter (max.)	Length, cable	Number of LEDs	Battery	Temperature range
3444910	KL-0880-10 K	5.0"	1280 x 720	+/- 180°	3.9 mm	1 m	6	5.000 mAh	-10 up to +60 °C

KL-1028-....

## CENTRING SLEEVES KIT

Made in Germany

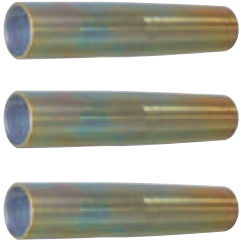

- The centring sleeve set enables easy and problem-free mounting of commercial vehicle wheels.
- The centring sleeves can be screwed on and off with a standard 1/2" reversible ratchet.

**Recommended accessories:**

1993 U-20 - reversible ratchet 1/2"

1/2"

Code	No.	Rim hole Ø	For bolt thread	Suitable for
1805126	KL-1028-1821	21 mm	M18x1.5	DAF, Unimog, Iveco, MAN, Renault, Volvo
2452219	KL-1028-1824*	24 mm	M18x1.5	DAF, Iveco, MAN, Renault, Volvo.
2452286	KL-1028-2026	26 mm	M20x1.5	Scania
1805134	KL-1028-2226	26 mm	M22x1.5	DAF, MAN, Mercedes, Ford, Renault, Scania, Volvo
1901761	KL-1028-7826	26 mm	7/8"-11 BSF	Scania aluminium rims
1901788	KL-1028-7830*	30 mm	7/8"-11 BSF	Scania aluminium rims

\* only while stocks last.

KL-0100-63..

## SOCKET SPANNER



**Fits with wheel hubs in the field of commercial vehicles.**

- For unscrewing and tightening wheel hubs

**Recommended accessories:**

KL-4007-411 - Articulated handle 980 mm

8571-01 - Torque spanner 520-1000 Nm

3/4"

Code	No.	Spanner size:	Length	Drive
2874229	KL-0100-632	32 mm	400 mm	3/4"
2874237	KL-0100-633	33 mm	400 mm	3/4"

KL-4007-411

## ARTICULATED HANDLE 3/4", 980 MM

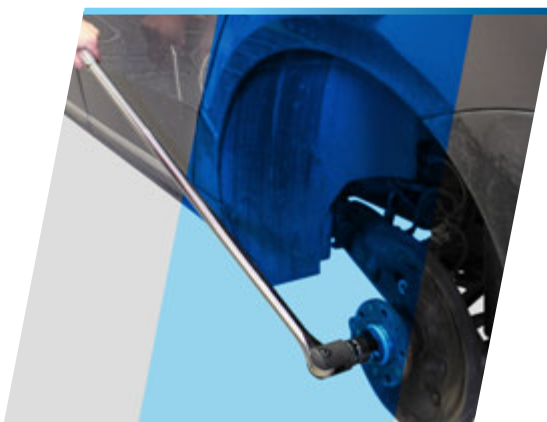

- For extremely stuck screw connections
- Especially long version
- With 180° joint

3/4"



Code	No.	Drive	Total length	Max. load:
2941554	KL-4007-411	3/4"	980 mm	1,050 Nm



TBI1000

## BREAKING TORQUE WRENCH 200-1,000 Nm



- Controlled bolt tightening in the range of 200 - 1,000 Nm
- Adjustable, bending, and robust torque wrench
- Integrated ratchet with square drive coupler (bit lock)
- For controlled r.h and l.h. fastening
- Maximum deviation of +/- 4 %
- Double scale Nm / lbf-ft



3/4"

Code	No.	Torque	Drive	Scale	Tolerance	Length	Weight
3108023	TBI1000	200 - 1000 Nm	3/4"	200 - 1000 Nm	+/- 4 %	1500 mm	7.5 kg

TF-K850

## TORQUE WRENCH TORCOFIX TF-K



- Controlled bolt tightening in the range of 250 - 850 Nm
- Adjustable, releasing, and robust pipe torque wrench with integrated ratchet
- Ergonomic handle, shaped according to the natural grip of the hand
- Maximum deviation of +/- 3 %
- For controlled r.h and l.h. fastening (pluggable square)
- Double scale - Nm and lbf ft with enlarged window



3/4"

Code	No.	Torque	Drive	Scale	Tolerance	Length	Weight
3278514	TF-K850	250 - 850 Nm	3/4"	10 Nm	+/- 3 %	1390 mm	4.8 kg

8563-N-05

## TORQUE WRENCH DREMOMETER DNR KIT 3/4" 155- 760 N·M



- Torque wrench with a tightening range of 155-760 Nm with aluminium extension tube
- For controlled right-hand tightening
- Incl. 3/4" external ratchet, clockwise
- Maximum deviation of +/-3% (more precise than the standard)
- Vernier scale - resolution 1.0 Nm

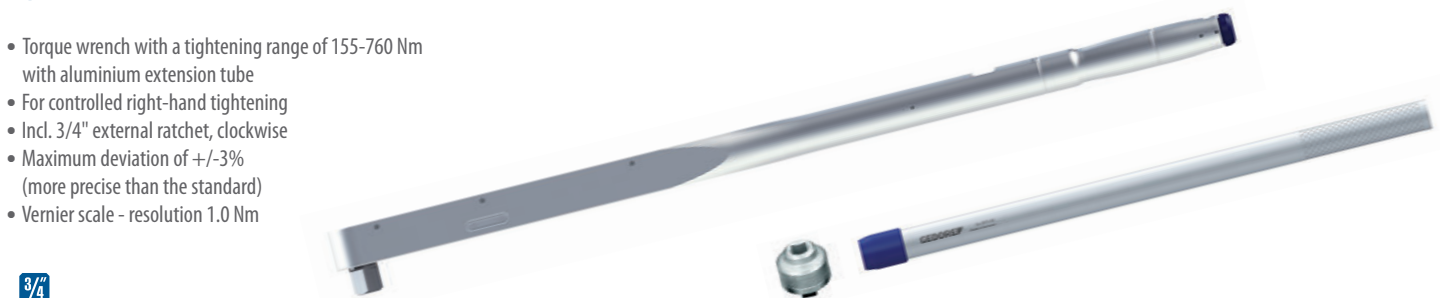

3/4"

Code	No.	Torque	Drive	Scale	Tolerance	Tightening direction	Length	Length with tube	Weight
3107043	8563-N-05	155 - 760 Nm	3/4"	10 Nm	+/- 3 %	Clockwise	812 mm	1400 mm	3 kg

1993 GU-10 XL

## JOINTED LEVER RATCHET 1/2"

Made in Germany



- Especially long version
- 180° swivelling
- With lowered switch lever
- With push button release
- Return angle 7.5°
- Non-slip 2-component handle with suspension hole
- Ratchet lock in middle position

1/2"

Code	No.	Length	Drive	Return angle	Max. torque	Weight
2018934	1993 GU-10 XL	600 mm	1/2"	7.5°	600 Nm	1160 g

28 LRV

## FOUR-WAY SOCKET WRENCH

Made in Germany



- For trucks and heavy machinery
- Vanadium steel 31CrV3, chrome-plated
- Turned centre piece, particularly stable

3/4"

Code	No.	Dimensions	4-edge	SW	Weight
6228420	28 LRV	750 x 750 mm	3/4"	27 / 30 / 32 mm	6.0 kg

KL-1029-20 A

## FORCING WHEEL PRESS / BODY PRESS

Made in Germany

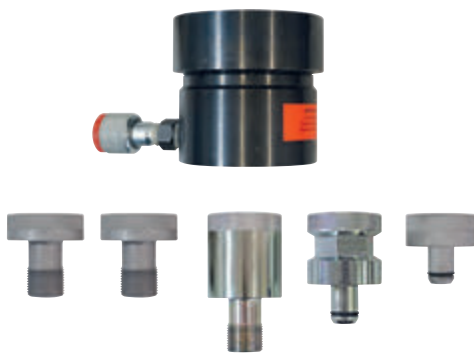

Fits universally for commercial vehicles, municipal vehicles, agricultural machinery, and passenger cars.

- For fast and powerful bead breaking of stuck wheels
- Also suitable for various straightening work on body parts
- Compact design for confined spaces
- Length adjustable by means of pressure pieces, extensions and fine adjustment

Code	No.	Max. load:	Variable total length	Max. hydr. cylinder stroke	Weight
3412865	KL-1029-20 A	17 t	120 - 250 mm	15 mm	4.6 kg

KL-1029-20 K\*

## COMMERCIAL VEHICLE WHEEL BEAD BREAKER



Fits universally for stuck commercial vehicle wheels.

- For easy removal of stuck wheels or rims from the wheel hub.
- Also suitable for twin tyres

\* only while stocks last.

Code	No.	Max. load:	Length (thrust piece 1)	Length (thrust piece 2)	Length (thrust piece 3)	Weight
2883627	KL-1029-20 K	10 t	25 mm	50 mm	75 mm	3.8 kg



KL-1000-0115

## RETAINER FOR WHEEL HUBS

Made in Germany

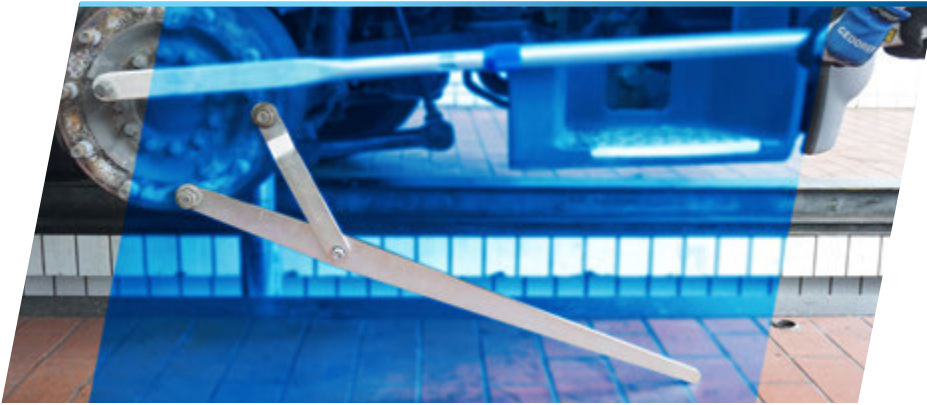

Fits universally for commercial vehicles, municipal vehicles, and agricultural machinery.

- Enables professional counter-holding of the wheel hub via the wheel studs
- For loosening and controlled torque-tightening of the wheel bearing, stub axle, and brake disc screw connections and those of the wheel capsule

**Suitability:** Universal

Code	No.	Length	Length of swivel arm	Bore diameter
3413195	KL-1000-0115	990 mm	315 mm	23 mm

KL-1029-300

## WHEEL HUB LIFTING ADAPTOR

Made in Germany



Fits universally for commercial vehicles and trailers.

- For easy and back-friendly lifting of heavy-weight wheel hubs
- One-man operation
- Stepless adjustment in order to keep the wheel hub in balance
- Versatile use, e.g. when changing brake discs

**Suitability:** Universal

Code	No.	Max. load:	Max. wheel bolt diameter:	Adjustment range	Weight
3413071	KL-1029-300	300 kg	22 mm	110 mm	1.1 kg

KL-1023-4...

## AXLE NUT SOCKET

double hexagon

Made in Germany



- Required for professional unscrewing and tightening of hub caps or axle nuts

**Recommended accessories:**

8581-01 - Torque wrench 600-1500 Nm



Code	No.	Socket size:	Drive	Height	Suitable for	Weight
3134857	KL-1023-4065	65 mm	1"	75 mm	IVECO commercial vehicles with the axle nut 7180039	1.8 kg
3135845	KL-1023-4080	80 mm	1"	75 mm	DAF, Mercedes, Renault and Volvo commercial vehicles	2.3 kg
3135853	KL-1023-4085	85 mm	1"	75 mm	IVECO commercial vehicles	2.4 kg
3134865	KL-1023-4090	90 mm	1"	75 mm	IVECO commercial vehicles	3.3 kg
3221199	KL-1023-4095	95 mm	1"	75 mm	IVECO, Renault and Volvo commercial vehicles as well as for Kögel axle systems	2.8 kg
3134881	KL-1023-4105	105 mm	1"	75 mm	DAF, IVECO, Renault and Volvo commercial vehicles	3.0 kg
3135861	KL-1023-4115	115 mm	1"	75 mm	IVECO commercial vehicles	3.7 kg



KL-4999-820 / 4999-8200

# MOBILE WORKSHOP/ ASSEMBLY TROLLEY MODULO FOR COMMERCIAL VEHICLES

In its unique composition, the assembly trolley "MODULO 820/8200" for commercial vehicles is the ideal mobile workstation for fast, organised, and efficient repairs.

Universally applicable for repairs on wheel bearings, steering and axle systems on commercial vehicles, buses, construction machinery, agricultural machinery, trailers, and semi-trailers.

**1**



#### Body:

- Dimensions: H 985 x W 1200 x D 635 mm
- 30 mm thick multiplex laminated beech board, surface additionally protected by linseed oil varnish
- Worktop offset to the rear allows flush parking against the wall
- A drawer unit in trolley width
- Manoeuvrable and easy to steer with drive/steer handle
- Side panels with Euro perforation 10 x 38 mm for attaching hooks and tools
- Sheet steel, corrosion-resistant and scratch-resistant powder-coated, GEDORE blue

#### Drawers:

- Design with four drawers
- Central lock with cylinder lock
- Wide drawers (W 998 x D 474 mm) with full extension, can be taken out
- Single lock prevents opening of more than one drawer, one-hand operation
- Ball-bearing guide rails with self-closing mechanism
- Load-carrying capacity per drawer 70 kg
- Sheet steel, corrosion and scratch-resistant powder-coating, GEDORE blue



**2**



- KL-0039-1003 - Mounting adapter for hydraulic cylinders
- KL-0039-2120-2 - Quick-release nut (M20)
- KL-0040-2812-1 - Thrust/pull spindle (M24 x 590 mm)
- KL-0040-2812-5 - Thrust nut (M24)
- KL-0040-2846-1 - Pull spindle (M20 x 590 mm)
- 32... - Sockets, 3/4" (hexagon: 22, 24, 27, 30, 32, 36, 38, 41, 46 mm)
- 3287 - Cross-handle, 3/4" (500 mm)
- 3290... - Extensions, 3/4" (200 + 400 mm)
- 3293 U-2 - Reversible ratchet, 3/4"
- 7 XL... - Ring-fork spanner (extra long): 10, 11, 12, 13, 14, 15, 16, 17, 18, 19, 21, 22, 24, 27, 30, 32, 36, 41 mm
- IN 32 L 14-155 - Screwdriver bit socket, 3/4" (inner hexagon: 14 mm)

**3**

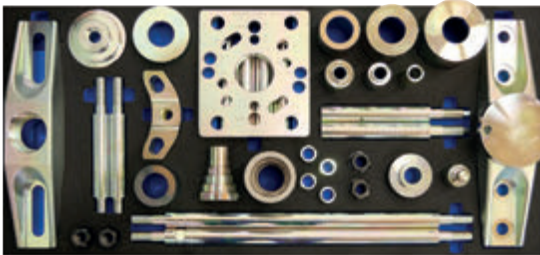

- KL-1005-100 A - Wheel hub puller kit
- KL-1005-110 - Wheel hub puller compact bearing
- KL-1039-111 - Press frame 28 tonnes

**4**



- KL-0040-2800 - Hydraulic cylinder 28t
- KL-0165-3 A - Set of ball joint breakers (with six forks)
- KL-0169-82 - Removal tool for tie-rod end
- KL-1010-1010 - Drive sleeve set Ø70 mm
- KL-1010-120 A - Thrust piece/sleeve set Ø60 mm
- KL-1010-140 B - Thrust piece/sleeve set Ø65 mm
- KL-1029-300 - Wheel hub lifting tool
- KL-1070-1224 - Slogging double ring wrench SW24
- 600 E-1500 - Metalworker's hammer 1.5 kg

**Content / range of application:**

- Various drive parts for operating the tool kits (depending on model with hydraulic cylinder 28 t)
- Pressing out wheel hubs with removable hub cap
- For wheel hubs with bolt circle diameters 8x275 mm and 10x335 mm
- For wheel hubs with bolt circle diameters 8x275 mm and 10x335 mm
- For pressing bushings, bearings, and bolts in and out
- Removal and installation of slotted and closed silent blocks

- Separating of ball joint connections on steering and axle systems
- Loosening and adjusting of tie rod ends
- Lifting of heavy-weight wheel hubs with a workshop crane
- Loosening and tightening of brake calliper screw connections which are hard to unscrew
- Including high-quality GEDORE hand tools

**The suitable hydraulic pump can be found on page 21.**

**93 parts**

Code	No.	W/H/D	Load-carrying capacity (static / dynamic)	Content
3425835	KL-4999-820	1,200 / 985 / 635 mm	1,000 kg / 750 kg	<b>incl.</b> hydraulic cylinder
3427587	KL-4999-8200	1,200 / 985 / 635 mm	1,000 kg / 750 kg	<b>without</b> hydraulic cylinder

KL-4999-1280

**SURFACE-MOUNT WORKTOP**  
for KL-4999 series / 1507 XL



**Fits the MODULO workshop trolley KL -4999 series and GEDORE 1507 XL.**

- To be placed on the wooden worktop
- Extremely robust, impact resistant and oil resistant
- With 2x can shelves and 8x storage compartments

**NEW**

Code	No.	Inner plate dimension	Material	Weight
3428001	KL-4999-1280	1202 x 639 mm	Impact and oil resistant ABS hard plastic	3.2 kg

KL-1005-111 Z

**WHEEL HUB PULLER, MECHANICAL**

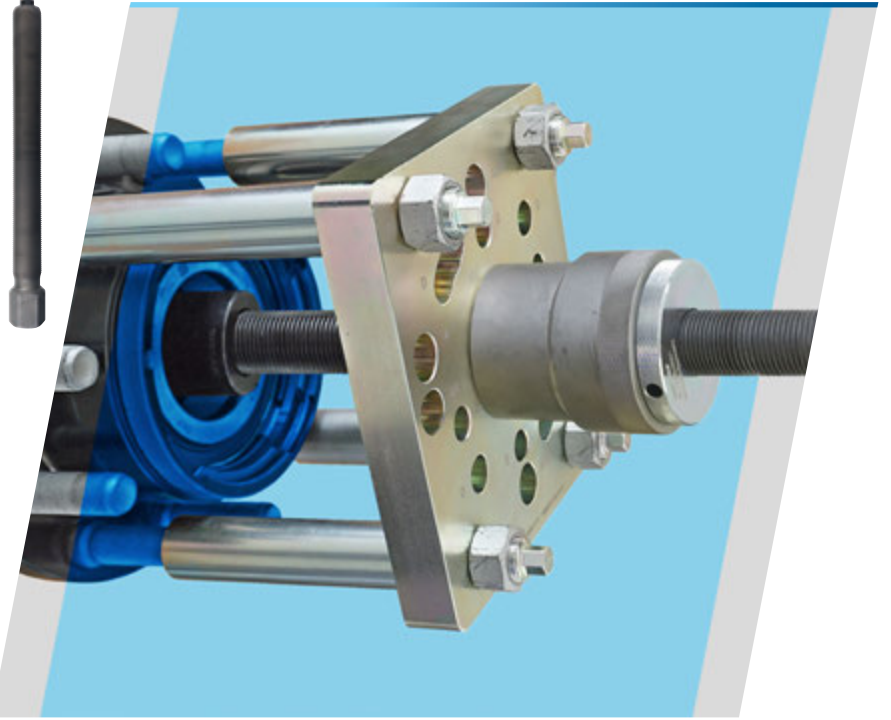
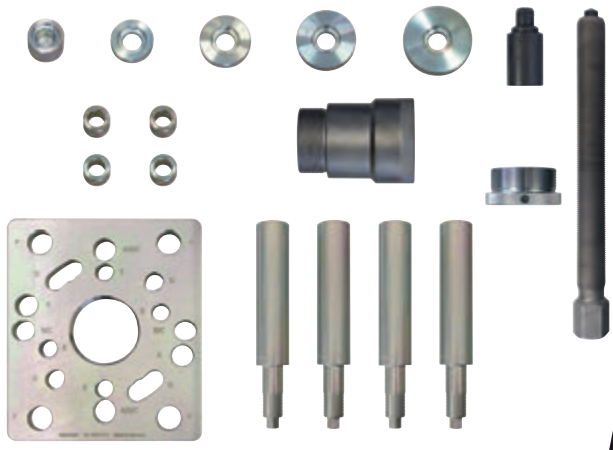

Universally suitable for commercial vehicle wheel hub/bearing units with removable hub cap.

- For a bolt circle dia. at the hub of 10x120, 10x122, 10x143, 10x165, 10x168, 10x225, 12x144, 12x145, 12x164, 12x168, 14x138, 14x144 mm
- For professional pulling of wheel hub/bearing units
- A hydraulic drive with 28 t cylinder is also possible (accessories required)

Suitability: Universal

Code	No.	Max. load (tool kit)	Bolt circle hub	Pitch circle hub wheel hub for low-loaders
3418596	KL-1005-111 Z	28 t	10x120, 10x122, 10x143, 10x165, 10x168, 12x144, 12x145, 12x164, 12x168, 14x138, 14x144	10x225

KL-1005-100 A Z

**WHEEL HUB PULLER SETS, MECHANICAL**

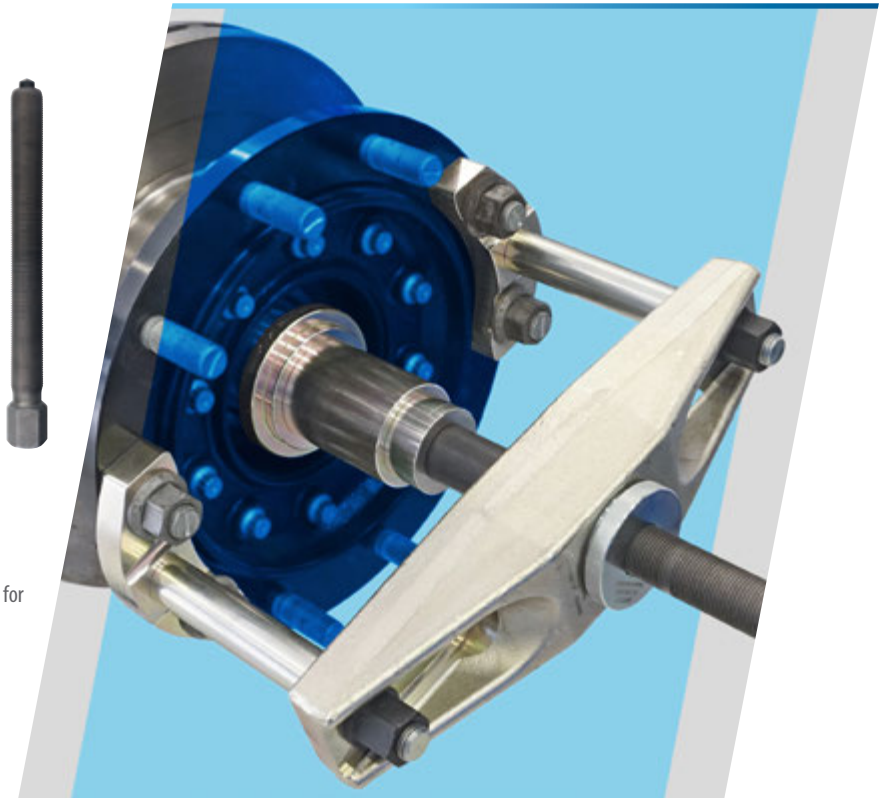
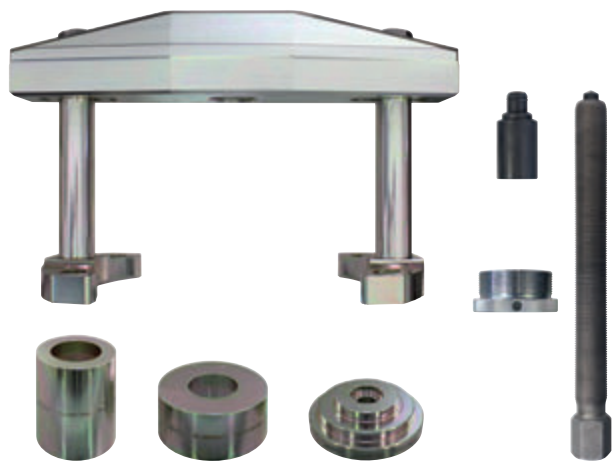

Universal fit for commercial vehicles (as well as wheel hubs with integrated compact wheel bearing) with removable hub cap.

- For axle systems with a pitch hole diameter of 8x275 mm and 10x335 mm for BPW, SAF, and ZF
- For professional removal of the wheel hub directly on the vehicle
- A hydraulic drive with 28 t cylinder is also possible (accessories required)

Suitability: **MERCEDES** **MAN** **RENAULT**  
**VOLVO** **IVECO** **SCANIA**

Code	No.	Hole circle Ø	Max. load on tool kit	Axle systems
3418588	KL-1005-100 A Z	8 x 275 mm / 10 x 335 mm	28 t	BPW, SAF, ZF



KL-1005-800

## MECHANICAL DRIVE KIT

Made in Germany



- For simple, mechanical drive of the commercial vehicle wheel hub puller sets **KL-1005-1...**
- Can also be used on press frame **KL-1039-111** with thrust spindle **1.3306500** (accessory)

Code	No.	Thread	Spanner size	Working length
3412881	KL-1005-800	G1"	36 mm	310 mm

KL-1027-4560

## WHEEL-BEARING CENTRING SLEEVE

60 mm diameter

Made in Germany

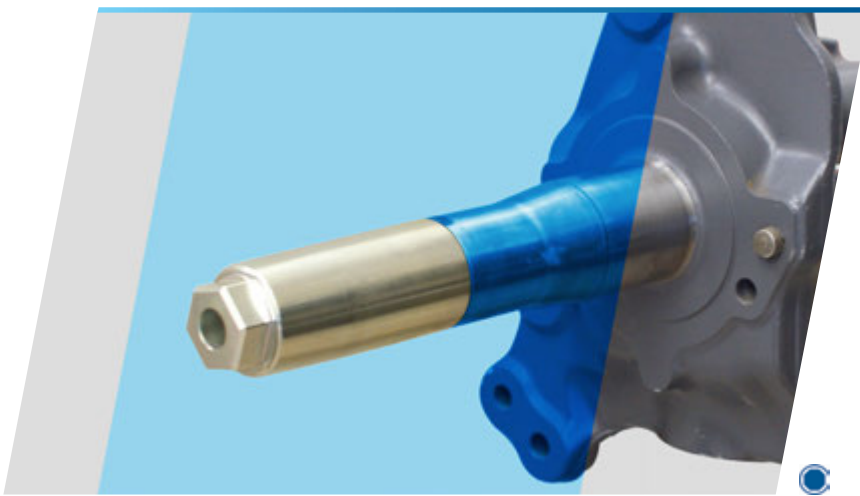

Suitable for Mercedes front axle.

- For the assembly of the compact wheel bearing with wheel hub
- For precise pushing onto the axle tube

Suitability: **MERCEDES**

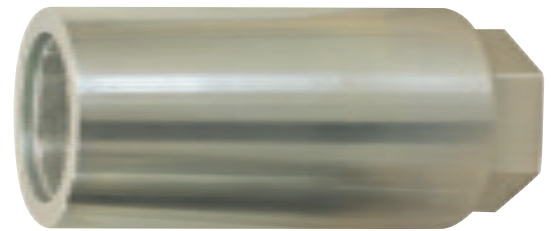

Code	No.	Connection thread	Outside diameter	Length	Spanner size
2672588	KL-1027-4560	M45x1.5	60 mm	145 mm	41 mm

KL-1027-45..

## WHEEL BEARING CENTRING SLEEVE

Made in Germany



Suitable for SAF axles with right-hand or left-hand thread

- For the assembly of the compact wheel bearing with wheel hub
- For precise pushing onto the axle tube

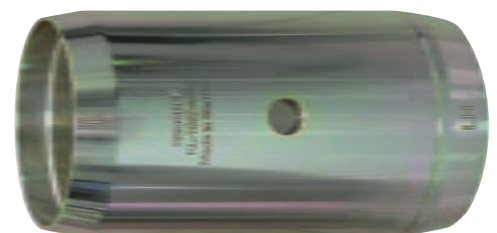

Code	No.	Designation	Connection thread	Outside diameter	Length
2991519	KL-1027-4582	Wheel-bearing centring sleeve 82 mm diameter	M75x1.5 (right-hand & left-hand thread)	150 mm	82 mm
2991527	KL-1027-4588	Wheel-bearing centring sleeve 88 mm diameter	M75x1.5 (right-hand & left-hand thread)	150 mm	88 mm

**NEW**



KL-0173-460 K

**RETHREADING TOOL KIT M50 - M110x1.5**  
for right-hand and left-hand thread

Universally fits all M50 - M110x1.5 right-hand and left-hand threads, for example on commercial vehicles, buses, construction machinery, agricultural machinery, trailers, and semi-trailers.

- QUICK, PROFESSIONAL, and CHIPLESS, simply EFFICIENT!
- Simple and quick rethreading of external threads directly on the vehicle
- Time-consuming and costly axle replacements in case of damaged axle threads are no longer needed
- Chipless rethreading of the thread by rolling (forming, pressing, shaping)
- No material removed, in comparison to thread cutting and filing
- Original geometry and strength is completely maintained
- Surface on the thread is additionally compacted again
- Thread remains up to 2 times higher dynamic load capacity
- Further thread roller sets also available as accessories

**Recommended accessories:**

KL-0173-4601 - Set of thread rollers for 1 mm pitch

KL-0173-4604 - Set of thread rollers for 2 mm pitch

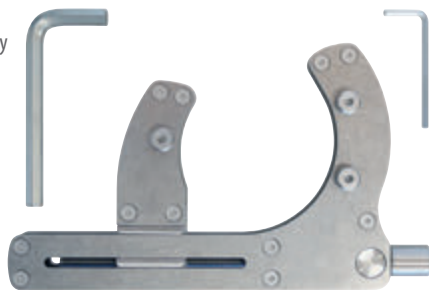

Made in Germany



**NEW**



Code	No.	for thread	Type of thread	Pitch	Content
3436217	KL-0173-460 K	M50 - M110	Right-hand / left-hand thread	1.5 mm	9 piece

Made in Germany



KL-0173-4601

**SET OF THREAD ROLLERS**  
for 1 mm pitch

**NEW**

- For use with the rethreading tool

KL-0173-460 K

- Suitable for right-hand thread with 1 mm pitch



Code	No.	Thread pitch	Thread
3436098	KL-0173-4601	1 mm	Right-hand pitch

Made in Germany



KL-0173-4604

**SET OF THREAD ROLLERS**  
for 2 mm pitch

**NEW**

- For use with the rethreading tool
- Suitable for right-hand thread with 2 mm pitch



Code	No.	Thread pitch	Thread
3436160	KL-0173-4604	2 mm	Right-hand pitch



KL-1010-90 K

## SILENT BLOCK TOOL KIT

Made in Germany



Universally suitable for slotted and closed silent blocks on commercial vehicles.

- For outside diameters (installed/removed) 51/52, 60/62, 63/65, 65/70, 75/80 mm
- Enables the quick and professional removal and installation directly on the vehicle
- Additional mechanical drive parts necessary!

Suitability: Universal, particularly for



**NEW**

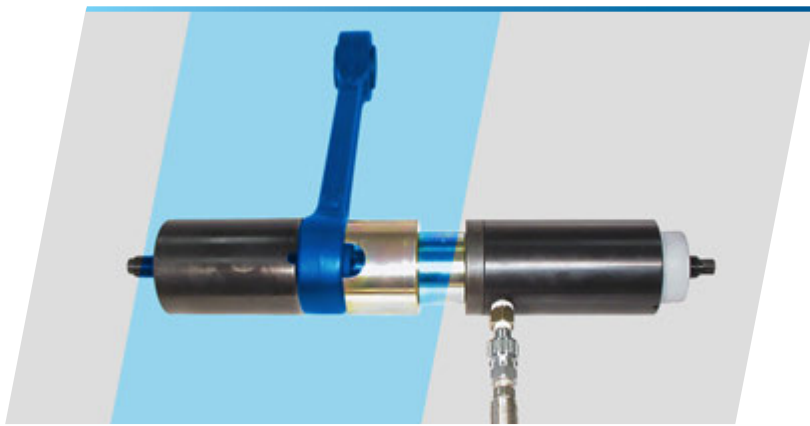

Code	No.	Bearing diameter (installed)	Width (case)	Depth (case)	Height (case)
3425703	KL-1010-90 K	51 / 60 / 63 / 65 / 75 mm	442 mm	357 mm	151 mm

KL-1010-106 K

## DRIVE KIT 28T FOR KL-1010-SERIES

Made in Germany

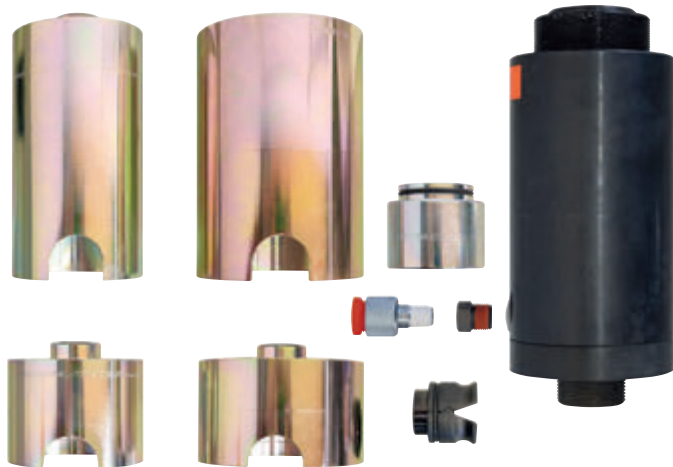

**NEW**

Appropriate drive parts for the commercial vehicle tool kit KL-1010-90-K.

Hydraulic pump required!

Consisting of:

- Hydraulic cylinder 28t
- Pulling spindle M20 x 590 mm
- Quick-release nut M20
- Mounting adapter
- Support sleeves, long, Ø 70 / 90 mm
- Support sleeves, short, Ø 70 / 90 mm



Code	No.	Max. load on the hydraulic cylinder	Max. load of pull spindle:	Width (case)	Depth (case)	Height (case)
3427846	KL-1010-106 K	28 t	20 t	442 mm	357 mm	151 mm

KL-1011-121

## BPW SILENT BLOCK TOOL

Made in Germany



Suitable for silent blocks with an axle bore diameter of 132 mm.

- For quick and professional insertion and removal on the wishbone
- For steel-rubber bushings No. 02.0314.38.00
- For example, on BPW ECO Air/ECO Air Compact axles
- Additional mechanical drive parts necessary!

Suitability: Universal

**NEW**

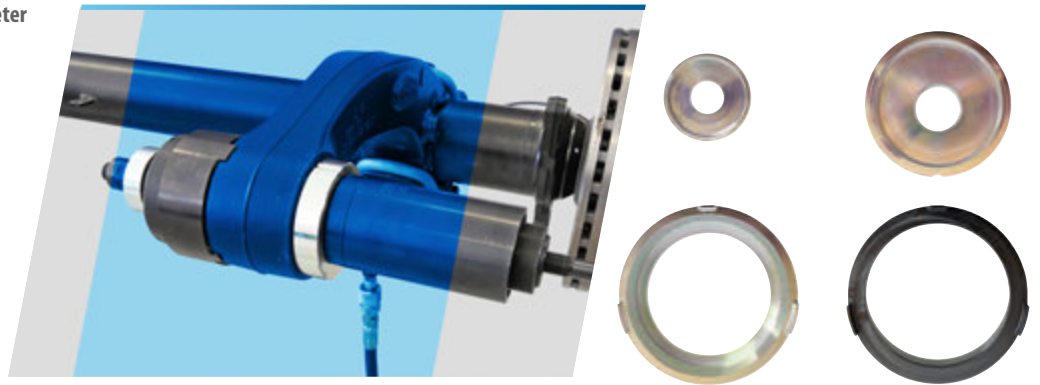

Code	No.	Sleeve	Thrust piece bore	Weight
3417158	KL-1011-121	conical	eccentric	6.8 kg

KL-1011-111

## SLEEVE SAF TRUCK - SILENT BLOCK

Ø 139 mm

Made in Germany

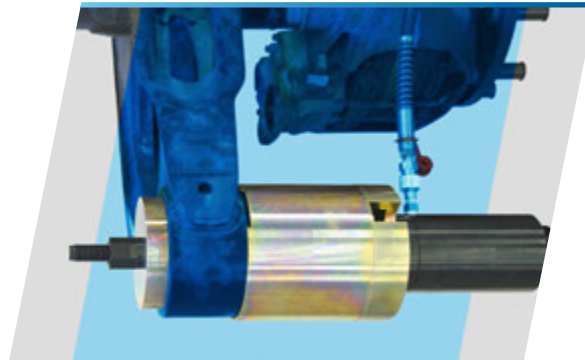
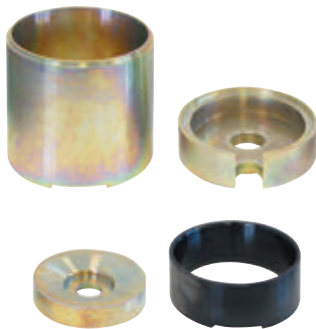

Suitable for silent blocs with a bore diameter of 139 mm; e.g. SAF Intradisc plus air suspension axles.

- For a quick and secure removal and installation on the axle suspension
- High time saving (approx. 4h)
- Repair can be performed directly on the vehicle
- Additional mechanical drive parts necessary!

Code	No.	for outside diameter (installed)	Drive type	Weight
2450178	KL-1011-111	139 mm	hydraulic	13.4 kg

KL-1039-1111

## SUPPLEMENT FOR KL-1005-100 A

to commercial vehicle press frame 28 t

Made in Germany



Universal fit for commercial vehicles, construction machines, agricultural machines, trailers and semi-trailers.

- For pressing bushings, bearings or bolts in and out **directly on the vehicle**
- Can be extended by pressure/support sleeves from the **KL-0039 series**
- Can also be used steadily due to its mounting base
- Length and width adjustable

Suitability: Universal

Only in combination with KL-1005-100 A (Additional mechanical drive parts necessary!)

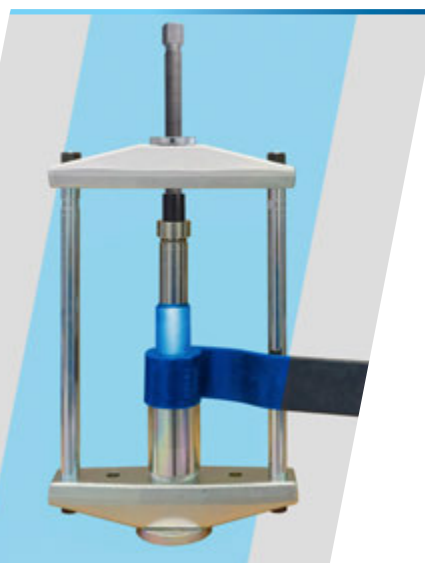

Code	No.	Width (inside)	Length (inside)	Max. load:
3275280	KL-1039-1111	180 - 320 mm	500 - 700 mm	28 t



KL-1002-1010

**DRIVE KIT M20**  
for hydr. cyl. With 89 mm

Made in Germany



- Driving GEDORE Automotive tools with a hydraulic cylinder from a foreign manufacturer (e.g. NIKE® hydraulics)

Code	No.	Max. load:	Length pull spindle	Thread pull spindle
2447509	KL-1002-1010	20 t	590 mm	M20 to UNC 1"-8

KL-0040-2800

**HYDRAULIC CYLINDER 28T**

Made in Germany



- The hollow-piston cylinder is suitable for pulling and pushing
- For the removal and installation of cardan shafts, silent blocks, wheel bearings and suspension joints

Code	No.	Max. admissible force	Max. stroke	Max. oil pressure	Thread with hollow piston	Fastening thread, pressure side	Fastening thread, pull side	Cylinder outside diameter	Connection thread for hydraulic coupling
2016893	KL-0040-2800	285 kN (28 t)	50 mm	700 bars	M24	2 3/4"-16 UN	M42x2	99 mm	3/8" NPT

KL-0215-36 M28

**HYDRAULIC PUMP, AIR-OPERATED**



- Can be used as hydraulic cylinder drive
- Compressed air is used for driving
- Foot pedal with three positions for pumping, holding, and relieving
- Both hand are free for the work

Code	No.	Max. pressure	Operating pressure	Weight
2478730	KL-0215-36 M28	700 bars	8 - 12 bar	8 kg

KL-1025-105

**SHAFT SEAL PRESSER Ø 105 MM**

Made in Germany



Suitable for MAN rear axles on the inner and outer shaft seal ring.

- For professional assembly of the outer shaft seal ring
- For professional assembly of the inner shaft seal ring with magnet wheel
- Improper assembly leads to leaks and ABS faults

Code	No.	Ø	Weight
3089304	KL-1025-105	105 mm	3 kg

KL-1025-175 A

**SHAFT SEAL PRESSER Ø 175 MM**

Made in Germany



**Suitable for Mercedes Actros and Atego rear axle shaft seal rings.**

- For professional assembly of the shaft seal
- Also for rear axles with double sealing
- Also for AP axles

Code	No.	Ø	Weight
3282708	KL-1025-175 A	175 mm	8.6 kg

KL-0169-81

**TIE ROD WRENCH SW34**

Made in Germany



**Suitable for tie or push rods with SW 34 mm on commercial vehicles, for example cranked rods with all-wheel vehicles.**

- For quick loosening and adjusting of sluggish track or push rods
- Uniform power transmission due to complete enclosing of the hexagon
- No need to replace the entire tie rod or push rod



Code	No.	Wrench size:	Drive	Design
3245810	KL-0169-81	34 mm	3/4"	Split

KL-0169-82

**LOOSENING TOOL FOR TIE ROD END**

Made in Germany



**Fits universally for tie rod ends on commercial vehicles, buses, and tractors.**

- For quick and professional installation and removal of sluggish tie rod ends
- Power transmission across the entire tie rod end
- No need to replace the tie rod or push rod
- Drive via 3/4" square socket



Code	No.	Drive	Height (inner)	Diameter (inner)	U-shaped cut-out	Height (outer)	Diameter (outer)
3267806	KL-0169-82	3/4"	70 mm	80 mm	65 x 40 mm	90 mm	95 mm

KL-0169-83

## TRACK ROD WRENCH, SIZE 30

Made in Germany

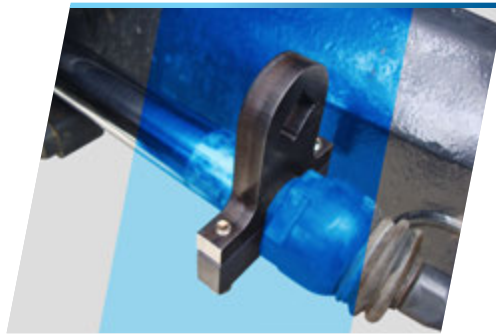

Suitable for tie rods with SW 30 adjustment thread, for example for Deutz-Fahr, Fendt, etc.

- For quick and professional loosening and adjusting of sluggish tie rods
- Closed power transmission via the counterholding surfaces
- No slipping or widening as with open-ended wrenches
- Conventional open-end wrenches are too wide
- No need to replace the tie rod or push rod

3/4"

Code	No.	SW	for profile	Drive (square)	Design	Length
3442748	KL-0169-83	30 mm	2-edge / hexagon	3/4"	separated	120 mm

KL-0167-30 A

## EXCENTRIC WRENCH

for quick removal and installation of axial joints

Fits universally for cars and vans.

For the quick removal and installation of internal track rod or rod or axial joints with a  $\varnothing$  of 30 - 43 mm.

- High time saving
- Without removing the steering gear
- Unique open construction
- Resistant profiling reliably prevents reliable slipping of the tool
- Direct mounting on the tie rod
- Drive via 1/2" square socket



Made in Germany



Application video



1/2"

Suitability: universally, especially for:



Code	No.	Drive	For $\varnothing$ (min.)	For $\varnothing$ (max.)
3427900	KL-0167-30 A	1/2"	30 mm	43 mm

KL-4007-3270

## EXTENSION 700 MM, 1/2"



Universal fit.

- Especially suitable for KL-0167-30 / -30 A
- For hand-operated socket spanners
- With ball lock.

1/2"

Code	No.	Drive	Length	Weight
3447707	KL-4007-3270	1/2"	700 mm	920 g



KL-0169-60

## TOE MEASURING GAUGE

Fits universally for passenger cars, commercial vehicles, vans, etc.

- For quick and simple toe difference measurement on the inner rim flange



Made in Germany



Code	No.	Toe difference scale	Measuring range
3230295	KL-0169-60	0 to 40 mm	950 - 1500 mm

## KL-0169-61 EXTENSION

- To extend the measuring range of the toe measuring gauge **KL-0169-60** from 1500 mm to a maximum of 2150 mm
- Only in combination with **KL-0169-60**



Code	No.	Length
3230317	KL-0169-61	670 mm

1.72/..

## BALL JOINT PULLER

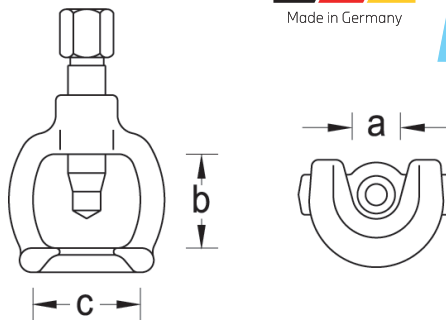

Made in Germany



- For simple and gentle pushing of the ball joint bolts on tie or push rods.

Code	No.	Drive	a	b	c
2183323	1.72/4A	22 mm	40 mm	80 mm	80 mm
2183331	1.72/5A	27 mm	46 mm	100 mm	90 mm

KL-0165-3 KA

## SET OF BALL JOINT BREAKERS (with 6 forks)



Made in Germany



Fits universally for commercial vehicles and vans.

- For breaking ball joint connections on axle and steering systems
- Variable due to exchangeable forks
- High stability
- Ideal release pressure point and breaking angle adjustable

Suitability: Universal



Code	No.	Size	Fork opening	Height (case)	Depth (case)	Width (case)
2801817	KL-0165-3 KA	3	30 - 47 mm	123 mm	360 mm	450 mm

KL-0165-35

## BALL JOINT BREAKER SIZE 3

Made in Germany

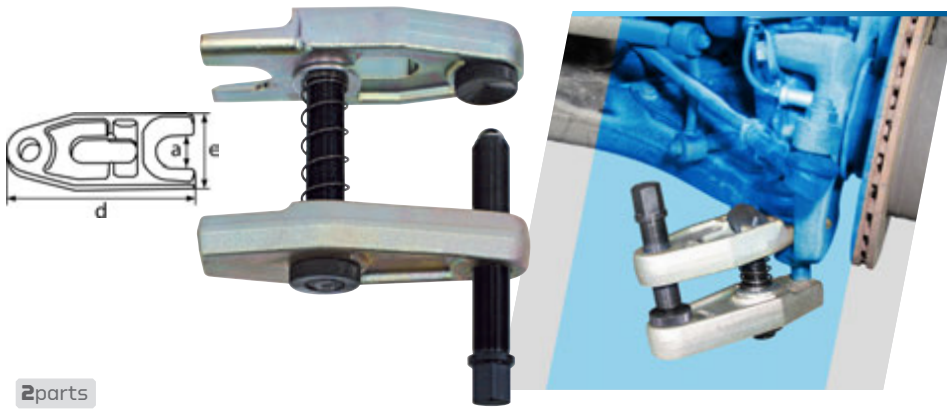

Suitable for support joints MB sprinter, VW LT, guide joint VW T4, MB Citaro EvoBus O 530 stabiliser ball joint etc.

- For removing ball joint connections on axle and steering systems
- Variable due to exchangeable forks

**Recommended accessories:**  
1993 U-20 - reversible ratchet 1/2"

**Suitability: universally, especially for:**



2 parts

Code	No.	Size	Fork width (e)	Fork opening (a)	SW	Spindle	Length (d)	Weight
1753614	KL-0165-35	Size 3	80 mm	33 mm	24 mm	M24x1.5 x 135	200 mm	5.6 kg

IN 32 L ...-155

## IN-HEX SOCKETS

Made in Germany



- For professional removal and tightening of brake calliper fastening screws
- The 155 mm long version also makes it possible to reach deep-seated brake calliper fastening screws

3/4"

Code	No.	Spanner size	Profile	Shaft length	Overall length	Drive
2003503	IN 32 L 14-155	14 mm	Inner hexagon	100 mm	155 mm	3/4"
1353705	IN 32 L 17-155	17 mm	Inner hexagon	100 mm	155 mm	3/4"
2003511	IN 32 L 19-155	19 mm	Inner hexagon	100 mm	155 mm	3/4"

KL-1072-100

## BRAKE CALLIPER LIFTING DEVICE

Made in Germany



Universal fit for approx. 90% of the brake callipers on commercial vehicles and trailers on the market.

- Enables easy and back-friendly lifting of heavy brake callipers with the aid of a workshop crane
- Positioning at a precise angle
- One-man operation

**Suitability:** Universal

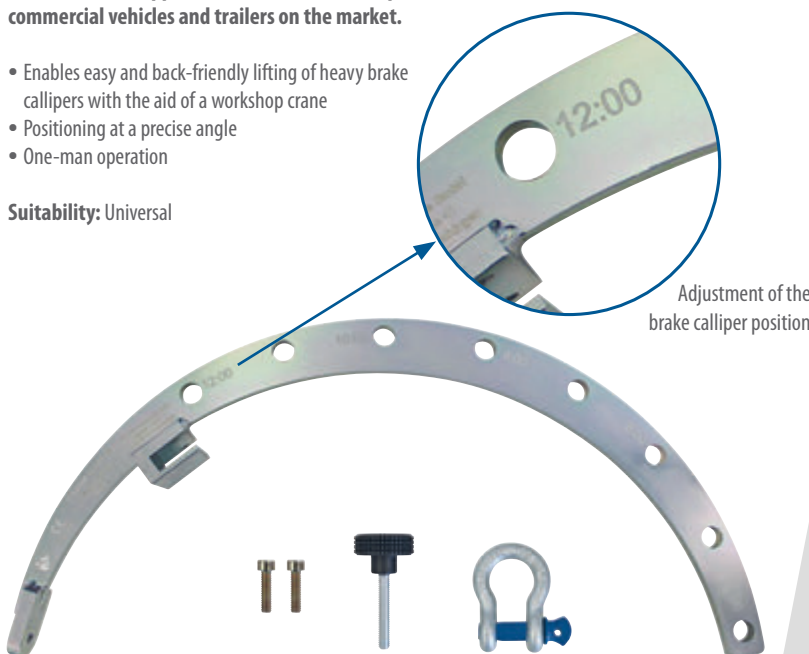

Adjustment of the brake calliper position

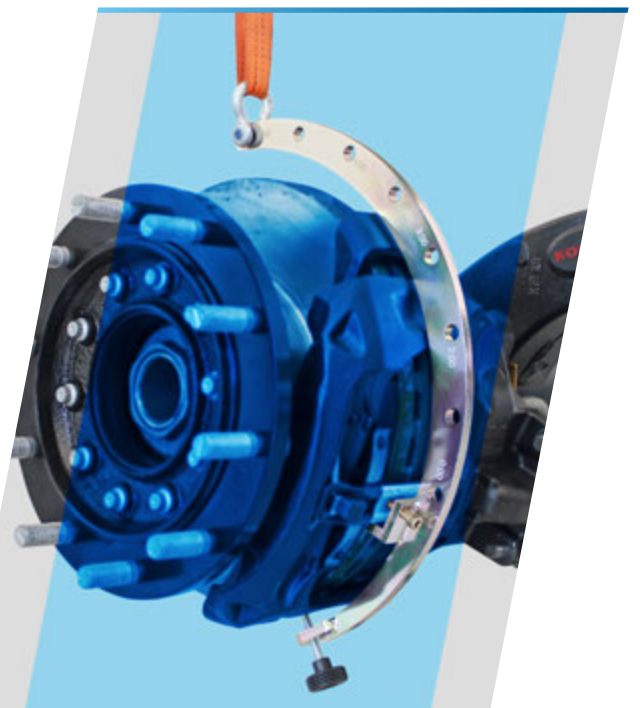

Code	No.	Max. load:	Brake calliper position	Shackle position	Weight
3415589	KL-1072-100	75 kg	0:00 to 5:00 / 7:00 to 12:00	8-way, adjustable	2.1 kg

KL-0114-22

## BRAKE SPRING PLIERS COMMERCIAL VEHICLES



Universally applicable.

- For unhooking and rehooking brake shoe retaining springs
- For air or hydraulic drum brakes
- Especially strong version

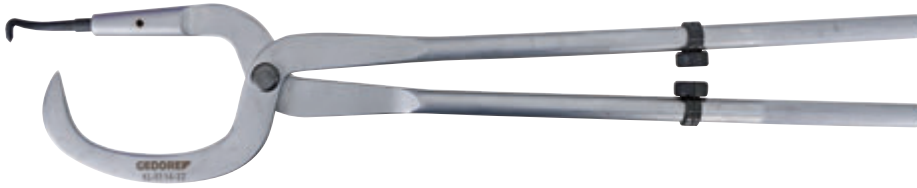

Code	No.	Length	Weight
1858076	KL-0114-22	535 mm	1150 g

KL-0121-512

## HOSE CLAMP PLIERS



**NEW**

Universal fit.

- For removal and installation of hoses secured by spring band clamps
- For straight or 90° offset applications



Code	No.	Design	Length	Weight
3435504	KL-0121-512	extra song	535 mm	1.1 kg

KL-1070-13..

## DOUBLE SLOGGING SPANNER

Made in Germany



Can be used on screw connections with hexagonal, double hexagon and Torx® profiles.

- Unique slogging spanner with double spanner profile
- Easy-made loosening and tightening of tight-fitting screw connections
- Professional tightening of the fittings according to their torque with 3/4" inner square
- High industrial quality for heavy and permanent use
- Slim design for areas which are hard to reach
- Engraved torque conversion formula

**NEW**

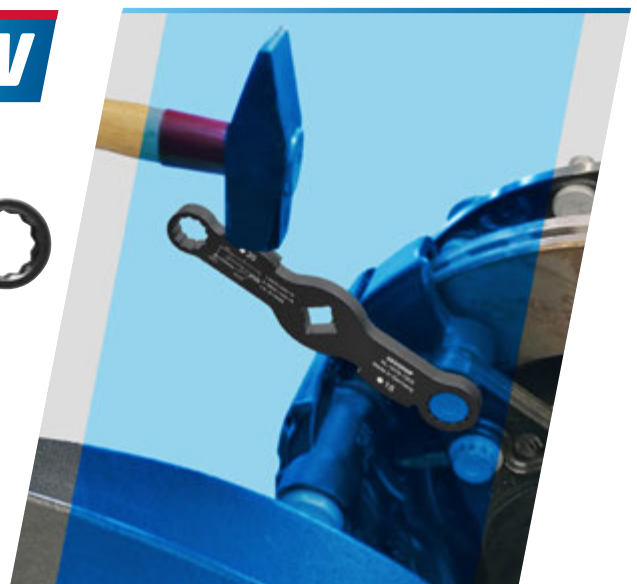

Code	No.	Length	Spanner size	Profile	Square socket
3424766	KL-1070-1301	235 mm	21 mm + 24 mm	12-edge	3/4"
3434222	KL-1070-1302	235 mm	19 mm + E24	12-edge / TX	3/4"
3434257	KL-1070-1303	235 mm	E18 + E20	TX	3/4"



KL-0190-55

## PLIERS FOR AIR LINE



Fits universally for plastic compressed air lines with an external diameter of 6, 8, 10, 12, and 16 mm.

- For a stable and damage-free fixing of the plastic compressed air line
- Helpful when installing a knock-in nipple or line connector

Code	No.	For line diameter	Length
3036324	KL-0190-55	6, 8, 10, 12, 16 mm	280 mm

KL-0132-14 K

## THREAD REPAIR KIT FOR EXHAUST SENSOR

Made in Germany



Universal fit for NOx sensors, lambda sensors, and injection units for soot/particle filter regeneration with mounting threads M20x1.5 and M22x1.5.

- For quick recutting of coked or damaged mounting threads on the exhaust pipe
- Also for very confined spaces
- No removal of the entire exhaust pipe necessary
- Incl. open ring spanner for loosening and tightening the exhaust sensors and units



5 parts

Code	No.	Tap	Tap length	Tap drive	Double ring spanner
3430847	KL-0132-14 K	M20x1.5 + M22x1.5	45 mm	SW13 mm	SW22 + 24 (open)

KL-0363-2 A

## MOTOR ROTATION DEVICE with 2 gearwheels



Suitable for Mercedes 6-, 8 and 10 cylinder MAN 12 cylinder commercial vehicle engines.

- For precise spinning of the engine, e.g. when adjusting the valves

1/2"

Code	No.	Drive	for engine type	Design	Weight
3036421	KL-0363-2 A	1/2"	Diesel	2 gearwheels	470 g

KL-0363-3 A

## MOTOR ROTATION DEVICE with 3 gearwheels



Suitable for Mercedes 4, 6 and 8 cylinder MAN 5, 6 8 cylinder commercial vehicle engines.

- For precise spinning of the engine, e.g. when adjusting the valves

1/2"

Code	No.	Drive	for engine type	Design	Weight
3036456	KL-0363-3 A	1/2"	Diesel	3 gearwheels	800 g

KL-0363-4

## MOTOR ROTATION DEVICE

with 1 gearwheel



Fits for MAN 6 and 8 cylinder commercial vehicle engines. (Engine code: D20, D25, D26, D28)

- For an exact rotation of the engine

1/2"

Code	No.	Drive	for engine type	Design	Weight
2432366	KL-0363-4	1/2"	Diesel	1 gearwheel	480 g

KL-0363-5

## MOTOR ROTATION DEVICE



Fits for Volvo and Renault 6 cylinder commercial vehicle engines.

- For precise spinning of the engine, e.g. when adjusting the valves

1/2"

Code	No.	Drive	for engine type	Design	Weight
3036359	KL-0363-5	1/2"	Diesel	1 gearwheel	790 g

KL-0363-7

## MOTOR ROTATION DEVICE

Made in Germany



Suitable for 5, 6 and 8 cylinder commercial vehicle engines.

- For precise spinning of the engine, e.g. when adjusting the valves

1/2"

Code	No.	Drive	for engine type	Design	Weight
3036383	KL-0363-7	1/2"	Diesel	1 gearwheel	230 g

KL-0363-8

## MOTOR ROTATION DEVICE



Fits for Volvo and Renault 6 cylinder commercial vehicle engines.

- For precise spinning of the engine, e.g. when adjusting the valves

1/2"

Code	No.	Drive	for engine type	Design	Weight
3036413	KL-0363-8	1/2"	Diesel	1 gearwheel	370 g

KL-0363-9 A

## MOTOR ROTATION DEVICE

Made in Germany



Suitable for DAF trucks with 6 cylinder (Euro 5 & 6) engines.

- For precise spinning of the engine, e.g. when adjusting the valves

1/2"

Code	No.	Drive	for engine type	Design	Weight
3282872	KL-0363-9 A	1/2"	Diesel	1 gearwheel	480 g

KL-0122-53

**FILTER SOCKET size 46**



Suitable for filter caps with SW46, for example Mercedes Blue Tec® motors on commercial vehicles.

- For unscrewing and tightening the filter cap

Suitability: Universal, particularly for **MERCEDES**



Code	No.	Spanner size:	Profile	Drive	Depth
2486059	KL-0122-53	46 mm	6-edge	3/8"	30 mm

KL-0122-51

**FILTER SOCKET size 32**



Universally suitable for filter covers with SW32.

- For unscrewing and tightening the filter cap



Code	No.	Spanner size:	Profile	Drive	Depth
1807390	KL-0122-51	32 mm	6-edge	3/8"	30 mm

36 1-140

**STRAP WRENCH**

Ø 140 mm

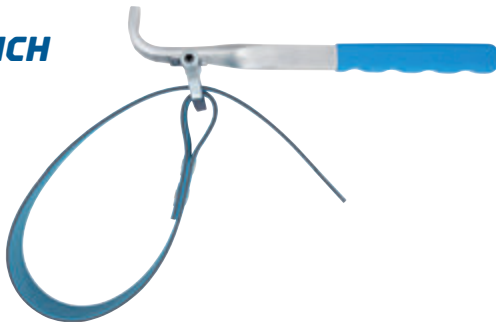

Made in Austria



- For unscrewing and tightening oil filter cartridges and caps
- With strong, non-slip fabric tape (E-36), extra wide = 25 mm
- Quality steel C45
- Chromed

Code	No.	Ø	Length	Strap width	Weight
6327320	36 1-140	140 mm	220 mm	25 mm	278 g

36 2-200

**STRAP WRENCH**

Ø 200 mm



Made in Germany



- With strong, non-slip fabric tape (E-36), extra wide = 25 mm
- GEDORE vanadium steel 31CrV3
- Chromed

Code	No.	Ø	Length	Strap width	Weight
6327400	36 2-200	200 mm	285 mm	25 mm	578 g

KL-0124-59

**RELEASE TOOL FOR HENN® CLAMP**



Made in Germany



Universally suitable for HENN® clamps on cooling water or charge-air hoses.

- For professionally loosening and unlocking HENN® clamps
- The handle can be moved by 90°
- Also suitable for hard-to-reach places

Code	No.	Length	Pin distance	Pin width	Weight
2961830	KL-0124-59	98 mm	16 mm	2 mm	120 g







1504 XL-5-198 AGRICULTURAL  
**FULL WORKBENCH**  
 with basic assortment  
 198 pieces

Made in Germany



Ideally suitable for service and maintenance work on agricultural machinery.

- Extensive socket spanner assortment in 1/4" and 1/2"
- Combination spanner kit SW 6-34
- Wide range of screwdrivers, pliers, impact tools, and many more
- Completeness check due to 2 coloured foam inserts
- Large storage space with lower shelf and door
- Safety through heel protection for persons
- Central locking with cylinder clock
- Drawers with full extension, removable
- Safety locking per drawer, one-hand operation
- GEDORE trapezoidal axle design for smooth running, manoeuvrability, and directional stability

**Recommended accessories:**

2005 CT3-32 - Spanner assortment 3/4" in foam insert

Code	No.	Load-carrying capacity per drawer	Load-carrying capacity lower drawer	Total load carrying capacity (static/mobile)	Dimension (WxHxD)	Weight
3434826	1504 XL-5-198	40 kg	60 kg	1,000 / 750 kg	1,250 x 985 x 630 mm	157.5 kg

1504 XL-5-306 AGRAR  
**FULL WORKBENCH**  
 with professional assortment  
 306 pieces

Made in Germany

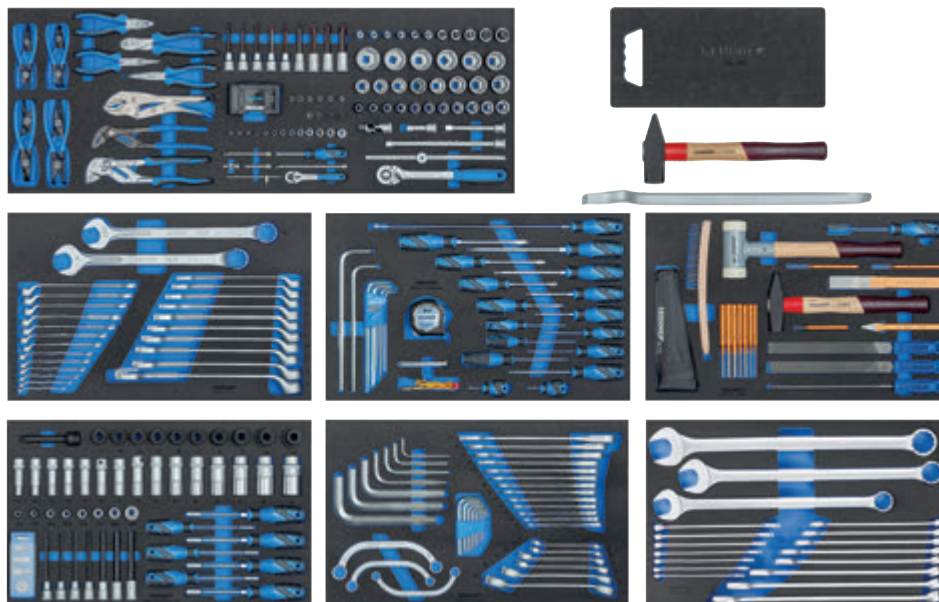

Ideally suitable for service and maintenance work on agricultural machinery.

- Extensive socket spanner assortment in 1/4" and 1/2"
- Combination spanner kit SW 6-34 (cranked) and SW 10 - 41 (XL)
- Ring ratchet open-end spanner, starter block spanner, open double ring spanner
- Wide range of screwdrivers, pliers, impact tools, and many more
- Completeness check due to 2 coloured foam inserts
- Large storage space with lower shelf and door
- Safety through heel protection for persons
- Central locking with cylinder clock
- Drawers with full extension, removable
- Safety locking per drawer, one-hand operation
- GEDORE trapezoidal axle design for smooth running, manoeuvrability, and directional stability

**Recommended accessories:**

2005 CT3-32 - Spanner assortment 3/4" in foam insert

Code	No.	Load-carrying capacity per drawer	Load-carrying capacity lower drawer	Total load carrying capacity (static/mobile)	Dimension (WxHxD)	Weight
3434834	1504 XL-5-306	40 kg	60 kg	1,000 / 750 kg	1,250 x 985 x 630 mm	183 kg



KL-4999-420

# MOBILE WORKBENCH WITH JUMBO COMMERCIAL VEHICLE ASSORTMENT

- Extensive product range for commercial vehicles/ agricultural machinery for professionals
- Tools in metric design
- Broad drawers with full-extension runners
- Central locking with cylinder clock
- Safety locking per drawer, one-hand operation
- Gently and neatly organised: Drawer placement with full-surface checking tool inserts
- Dimensions: H 985 x W 1200 x D 550 mm

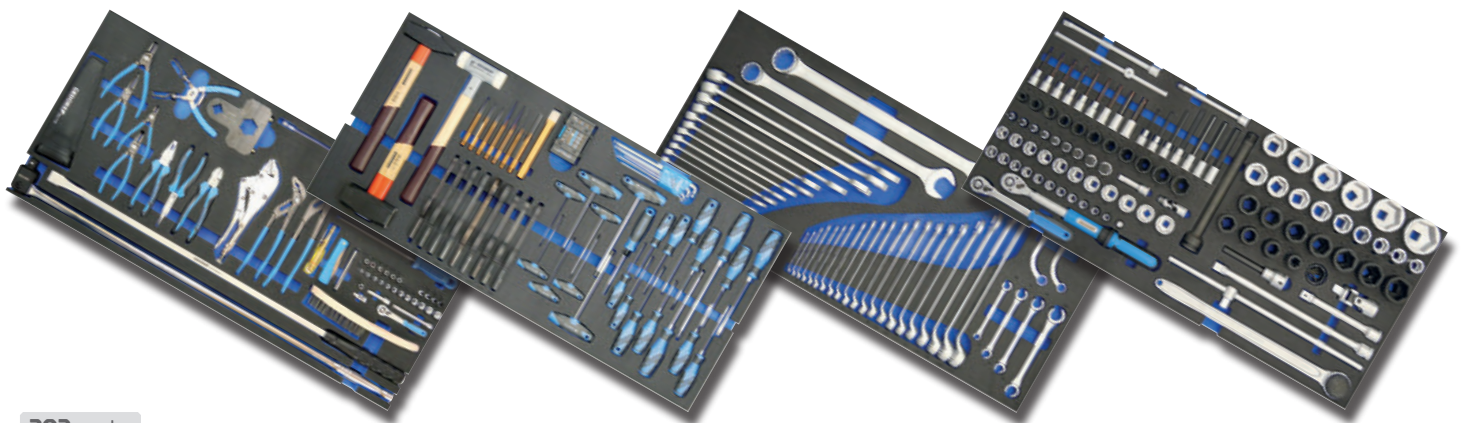

302 parts

Code	No.	Content	Total load carrying capacity (static/mobile)
3418367	KL-4999-420	1/4" assortment (SW 4-13, IN 4-8 and T8-T25) 1/2" assortment (SW 10-32, T20-T60 long, IN 6-19, and IN long 6-14, power screwdriver inserts SW 17-32, and telescopic ratchet) 3/4"-assortment (SW 21-60, E24 and IN long SW 14, and power screwdriver inserts SW 24-41, and articulated handle 980 mm) Bit set and ratchet screwdriver Screwdriver sets (slotted 4.5-8, PH 1-4, T10-T40, and IN 2-10) Spanner sets (SW 6-41 + brake line and starter block spanners) Impact wrench sets (E18/E20/E24, hex SW 24/26/27, and hex SW 19/21/24) Extensive range of pliers Extensive range of impact and lever tools Extensive range of measuring, cutting, and machining tools	1000 kg / 750 kg



2005 XL 0221  
**TOOL TROLLEY**  
 with 5 drawers

**NEW:**  
 extra wide drawers



Made in Germany



- Storage surface of ABS plastic with small parts compartment
- Manoeuvrable and easy to steer
- Side walls with Euro perforation
- With edge impact protection
- Central locking with cylinder clock
- Broad drawers with full-extension runners (removable)
- Safety locking per drawer, one-hand operation
- Even with maximum load capacity: smooth running, manoeuvrable, and directionally stable

Code	No.	Load capacity per drawer	Load capacity lower drawer	Total load capacity (dynamic/static)	Weight
3437515	2005 XL 0221	60 kg	70 kg	750 kg / 1,000 kg	92 kg

2005 XL 0330  
**TOOL TROLLEY**  
 with 6 drawers

**NEW:**  
 extra wide drawers



Made in Germany



- Storage surface of ABS plastic with small parts compartment
- Manoeuvrable and easy to steer
- Side walls with Euro perforation
- With edge impact protection
- Central locking with cylinder clock
- Broad drawers with full-extension runners (removable)
- Safety locking per drawer, one-hand operation
- Even with maximum load capacity: smooth running, manoeuvrable, and directionally stable

Code	No.	Load capacity per drawer	Load capacity lower drawer	Total load capacity (dynamic/static)	Weight
3437523	2005 XL 0330	60 kg	70 kg	750 kg / 1,000 kg	97 kg

BR 1500 LH  
**COMBINATION OF WORKBENCH**  
 with cabinet



Made in Germany



- Sheet steel, corrosion and scratch-resistant, powder-coated
- 40 mm strong, oiled multiplex laminated beech board
- Large storage space with roller blind
- Back panel with square perforation 10 x 38 mm
- Separated central lock for drawers and roller blind
- 5 broad drawers with partial extension (removable)

**Recommended accessories:**  
**1500 HS 23** - 85 piece hook assortment  
 Lengthwise (LD) and crosswise (CD) dividers

Code	No.	W / D / H	Working height	Load capacity per drawer	Total load carrying capacity	Weight
6618210	BR 1500 LH	2,000 mm / 875 mm / 1,790 mm	900 mm	40 kg	2,000 kg	203 kg

640-3000

## MAGNETIC LIFTER

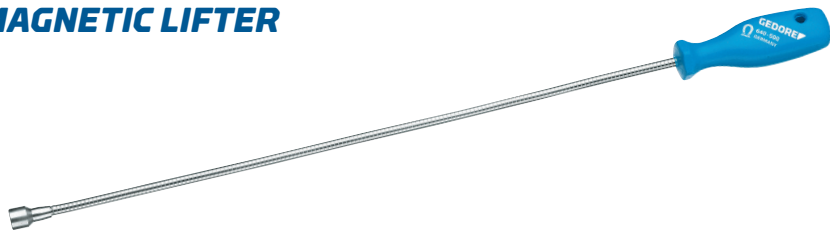

- With flexible shank and plastic handle
- Bright-nickel plated
- For picking up and holding small magnetic parts
- Easy handling due to flexible shaft
- For picking up components in blind holes

Code	No.	Length	Lifting power	Magnet-Ø
6531360	640-3000	520 mm	3 kg	16.5 mm

905

## ROLLER BOARD



- Robust and durable assembly/workshop bench
- Oil, grease and brake fluid resistant
- 6 ball-bearing 360° rollers and low construction height
- Comfortable head position on head and neck cushion
- Secure support and maximum freedom of movement
- The ergonomically shaped lying surface

Code	No.	Load capacity	Dimensions	Wheel Ø	Weight
1823698	905	130 kg	W 480 - H 115 L 1000 mm	77 mm	5 kg

906

## KNEEBOARD

Made in Germany



- Made of firm foam insert, blue/black
- With recessed handle

Code	No.	Length	Width	Height	Weight
1942948	906	450 mm	210 mm	30 mm	110 g

2150-2160 PH-06

## 3C SCREWDRIVER KIT, slot/cross-head PH



- Useful kit composition in an environmentally friendly cardboard packaging
- For PH slot and crosshead screws
- 3-component Power-Grip<sup>3</sup> handle with suspension hole
- Ergonomic handle shape for accurate, non-tiring work
- Positive-locking connection of handle and blade for optimal torque transmission
- Type of drive marked at the end of the handle
- Blade of galvanised molybdenum-vanadium steel

6 parts

Code	No.	Content	Weight
1482319	2150-2160 PH-06	3C screwdriver bit slot No. 2150, SW 4,5,5,6,5,8 mm 3C cross-head screwdriver no. 2160 PH 1 2	660 g

32 EMU-2

## SOCKET SPANNER KIT 3/4"

14 pieces, 6-edge  
22 - 50 mm

Made in Germany



- With forged, hardened and tempered, hand-operated hexagonal socket spanner
- Actuating tools made of GEDORE vanadium steel 31CrV3
- With fine-toothed reversible ratchet
- In GEDORIT blue sheet steel case

Code	No.	Dimensions	Drive	Weight
6280340	32 EMU-2	525 x 203 x 73 mm	3/4"	11.6 kg

7 XL-012

## RING-FORK SPANNER SET, extra long

Made in Germany



- Especially long version
- In a practical compilation
- With the same spanner sizes, ring side with an angle of 15°, with UD profile
- With hollow shaft
- GEDORE vanadium steel 31CrV3, chromed

Code	No.	Content
6095950	7 XL-012	10, 11, 12, 13, 14, 17, 19, 22, 24, 27, 30, 32

KL-4007-500

## WRENCH EXTENSION universal, 380 mm



- For easy extension of spanners and offset screwdrivers
- For loosening tight screw connections in spots which are hard to reach.



Code	No.	Length	Weight
3406504	KL-4007-500	380 mm	1.4 kg

900 20

## LI-MH LED LAMP USB CHARGING PORT

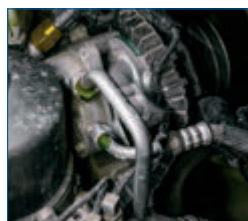
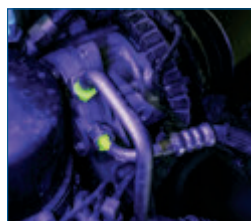

- Versatile LED/UV lamp with a slim design
- Infinitely dimmable, switchable from LED light to UV light blue-violet
- For finding leaks, for example in air conditioning systems, heat pumps, etc.
- Hooks can be folded out on both sides, powerful magnet on the 45° adjustable base
- Powerful mini magnet at the peak for collecting small parts
- Can be charged by the supplied power pack or a USB port

3 parts

Code	No.	Length	Brightness	Lamp power	Battery
3108678	900 20	477 mm	620 lumen	16 W	3.350 mAh



KLM-0202

## MKP LONGSLEEVE

- 100% Organic cotton (220 g/m<sup>2</sup>)
- Manufactured under fair working conditions
- Applications on chest, back, and arm



Code	No.	Size
3419401	KLM-0202-S	S
3419428	KLM-0202-M	M
3419436	KLM-0202-L	L
3419444	KLM-0202-XL	XL
3419452	KLM-0202-XXL	XXL

KLM-0402

## MKP SOFTSHELL WAISTCOAT

- Breathable with permanently water-repellent coating
- Windproof three-layer membrane fabric
- Zipped pockets, adjustable elasticated hem
- Manufactured under fair working conditions
- Application on the front



Code	No.	Size
3419517	KLM-0402-S	S
3419533	KLM-0402-M	M
3419541	KLM-0402-L	L
3419576	KLM-0402-XL	XL
3419584	KLM-0402-XXL	XXL



R95300139  
**PENLIGHT**



- Compact, slim size
- Protected against the intrusion of small dust particles and splash water
- Good grip even with oily and sweaty hands
- Can also be used with gloves
- Mobile companion for all applications
- Practical clip for attaching to belt, shirt or trouser pocket

Code	No.	Length	Ø	Burn time	Battery type	Battery quantity	Weight
3301758	R95300139	139 mm	15 mm	4 h	AAA	2 pcs	56 g

R95700089  
**MINI WORK LAMP**



- Extremely bright lamp in a very compact format
- Can be used especially in confined spaces
- Magnet provides different holding options in different working areas
- Enables hands-free working
- Mobile companion for all applications
- Practical clip for attaching to belt, shirt or trouser pocket
- Fits in every trouser pocket

Code	No.	Length	Burn time	Battery capacity	Charging time	Weight
3301759	R95700089	89 mm	3 h	600 mAh	2.5 h	35 g

R95600320  
**INSPECTION LAMP**



- Ideal as a work lamp for mobile use in various areas
- 5 switching functions for individually adjustable brightness
- Can be used both as an inspection lamp and as a torch
- Magnet and 180° rotating hook provide different holding options
- Enables flexible and mobile use, as well as hands-free working
- LED can be used both folded in and out

Code	No.	Length	Burn time	Battery capacity	Charging time	Weight
3301760	R95600320	320 mm	12 h	2.500 mAh	4 h	260 g

R95400145  
**SPOTLIGHT**



- Compact, portable spotlight
- Ideal for working in places without power supply
- Rubberised surround, therefore shockproof and splashproof
- 180° rotatable base
- Stand can also be hung up or used as a carrying handle
- Easy alignment of the light
- Power bank function for charging external devices

Code	No.	Width	Burn time	Battery capacity	Charging time	Weight
3301761	R95400145	145 mm	6 h	4.400 mAh	4 h	640 g



OCHSENKOPF is a sign for perfection and safety in forestry and carpenter's tools. Since its foundation in 1781 by the Fahlefeld brothers, the best steel with the best grind has been forged to the highest level of quality in the Remscheid axe forge. An OCHSENKOPF axe stands for craftsmanship at the highest level. It is still the pride of the traditional Bergisch tool industry. A brand like a myth.



OX 635 H-3009

**PROFI WOOD SPLITTING HAMMER BIG OX®**



- With ROTBAND-PLUS handle fastening
- Forged hammer head with reversible nose and extra large striking surface, e.g. for driving wedges
- With high-quality, swell-end handle made of hickory wood and blade protection

Code	No.	Weight (head)	Cutting edge width	Length	Weight (total)
1707663	OX 635 H-3009	3 kg	70 mm	900 mm	4.2 kg

OX 648 H-1257

**SPALT-FIX® AXE ROTBAND-PLUS**



- Optimum splitting result with low effort due to wedge-shaped blade design
- With ROTBAND-PLUS handle fastening
- With high-quality handle made of hickory wood

Code	No.	Weight (head)	Cutting edge width	Length	Total weight
1962396	OX 648 H-1257	1250 g	100 mm	717 mm	2.15 kg



OX 620 H-1257

## UNIVERSAL GOLD FORESTRY AXE ROT BAND-PLUS

Made in Germany



- With ROTBAND-PLUS handle fastening
- In addition, the long steel handle protection sleeve protects the handle in case of misses and guarantees a long service life
- Finely polished axe head with blade guard
- With high-quality handle in cow's foot shape made of hickory wood

Code	No.	Weight (head)	Cutting edge width	Length	Weight (total)
1879812	OX 620 H-1257	1250 g	120 mm	730 mm	2.3 kg

OX 31-0300

## PLASTIC FELLING WEDGE ALASKA

Made in Germany



- Made of high-quality, recycled polyamide plastic
- Extremely impact-resistant and therefore ideally suited for felling, even in extremely cold conditions
- Optimum wedging effect even in frozen wood

### Safety information:

Only suitable for felling, not for splitting

Code	No.	Overall length	Stroke height	Weight
1592068	OX 31-0300	230 mm	30 mm	265 g

OX 40-2000

## STEEL SPLITTING WEDGE

Made in Germany



- Forged solid wedge with guiding groove

### Safety information:

• Always drive in steel wedges with a hardwood or plastic hammer only. Hitting steel on steel can cause chips

Code	No.	max. stroke height	Width	Length	Total weight
1591975	OX 40-2000	31 mm	54 mm	250 mm	2 kg

OX 173 E-0500

## HAND SAPPIE

Made in Germany



- For moving and picking up smaller tree trunks and pieces of wood
- For an ergonomic and back-friendly working method
- With high-quality handle in cow's foot shape made of ash wood

Code	No.	Weight (head)	Length	Total weight
1592408	OX 173 E-0500	500 g	380 mm	775 g

KL-1000-20 A  
**KINGPIN  
 PRESS 65 t**  
 WITH SLEEVE SET



**Fits universally for commercial vehicles.**  
**For quick and professional insertion and removal of kingpins on commercial vehicles.**

**Advantages:**

- Pneumatic high-speed hoist!
- One-man operation!
- Developed to meet the latest safety requirements!
- Universal fit, on the vehicle as well as free-standing!
- High time saving!
- Universally adjustable press frame which can be turned by 180°!
- Easy and quick positioning on the vehicle due to the quick adjustment across three axes!

**Suitability: Universal**

Code	No.	Press force	Clear width/height (max.)	Stroke	Air connection (max.)	Weight
3091600	KL-1000-20 A	65 t	290 / 480 mm	120 mm	13 bars	130 kg

Your dealer/stamp:

**pronax group, s.r.o.**  
 www.pronaxnaradie.sk  
 pronaxnaradie@gmail.com  
 A. Popluhár +421 905 483 509  
 Revolučná 17, 821 04 Bratislava  
 sídlo: Nádražná 34  
 900 28 Ivanka pri Dunaji



**HEAVY DUTY** valid from 01.04.2023 to 31.12.2023  
 Only while stocks last.

Delivery without decoration. Subject to technical changes.  
 All information are subject to typographical and printing errors.

**GEDORE Automotive GmbH**  
 Breslauer Straße 41 | 78166 Donaueschingen | GERMANY  
 Phone +49 +4977183223-0 | info.gam@gedore.com

**gedore-automotive.com**